

# CROWN OPTO S13 INSTALLATION GUIDE

READ THE INSTRUCTIONS CAREFULLY BEFORE MOUNTING

IP66

RoHS Compliant

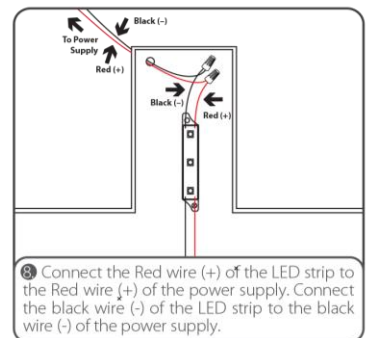
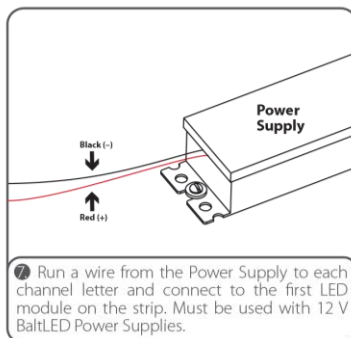
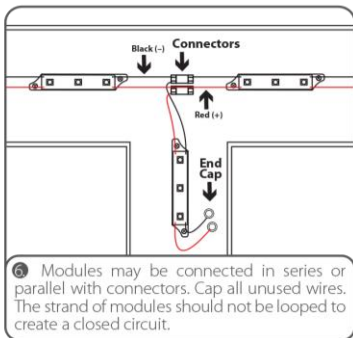
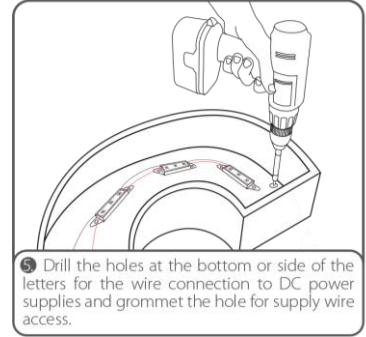
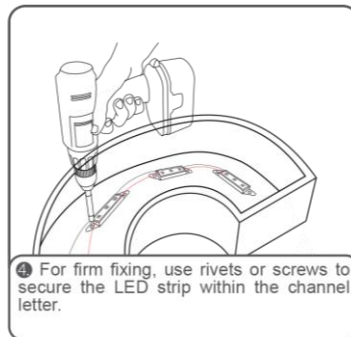
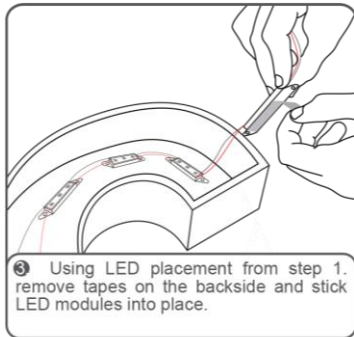
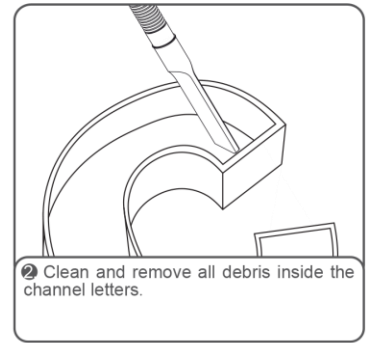
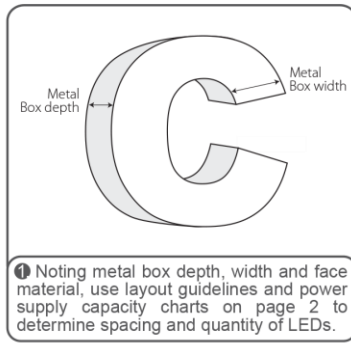

## CONNECTION SCHEME

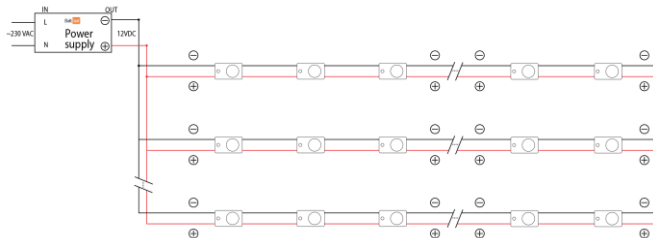

! 50 pcs - max number of modules in one chain when the power supplied from single end.  
! String end voltage can't be less than 11V, do not exceed specified module string length

## POWER SUPPLY LOAD RECOMMENDATIONS

POWER SUPPLY	QUANTITY		2 m*		5 m*		10 m*	
	strings	modules	mm <sup>2</sup>	AWG	mm <sup>2</sup>	AWG	mm <sup>2</sup>	AWG
BP3-V12-24.1	1	48	1.5	18	2.5	14	4	11
BP3-V12-36.1	2	71	1.5	17	2.5	13	6	10
BP3P-V12-36.1	2	71	1.5	17	2.5	13	6	10
BP3-V12-60.1	3	113	2.5	14	6	11	10	8
BP3P-V12-60.1	3	113	2.5	14	6	11	10	8
BP3-V12-100.1	4	177	4	12	10	8	16	7
BP3P-V12-100.1	4	171	4	12	10	8	16	7
BP3P-V12-200.1	8	357	6	9	16	5	35	2

\* Distance between power supply and modules.  
! Power loss less than 5%.  
! Recommendations for optimal use of power supply.

## MOUNTING AND USING RECOMENDATIONS

- Be careful not to go beyond recommended maximum quantities of modules for a power supply. Overload may cause blinking or a failure.
- Any type of self tapping screws can be used for mounting.
- These modules are designed to work with constant-voltage power supply. Use only recommended power supplies, do not connect to a constant-current power supplies as it will cause immediate failure of modules.
- Before installing make sure, that the fixing area can bear the total weight of the modules.
- Please install LED modules with appropriate cables. There is a possibility, that cables may get disconnected due to contractions, caused by temperature changes.
- Please check that sulphur constituent is not contained in used components when the module is installed.
- Make sure to install modules in a place with a sufficient breathability in order to prevent lifetime reduction by heat. Operating temperature should not exceed +50 °C.
- When installing a module in a fixture (signboard), make sure to provide ventilation for constituent sulphur, drainage for rain water to prevent aged deteriorations.
- When fixing cables of the modules do not use metal cable stop. The tunic of the cable may be damaged and therefore lead to short-circuited.
- Be sure to install modules at a maintainable place.
- In order to prevent LED from breaking down caused by static electricity, make sure not to touch the metal parts of the cable directly with bare hands.
- Make sure to apply correct polarity and direction of the modules. If mistaken, it will lead to failure and break down of the modules.
- When trying to perform lighting test (burn-in test), be sure to connect module to a power supply. Modules can fail to light up due to over-current. If the power supply is turned on without LED modules connected, modules can be connected only 5 minutes after the power supply has been turned off. Residual electricity may cause damage to modules.
- Avoid applying force while bending, twisting or pulling the power supply cables to minimize the risk of electrical shock.
- If any signs of smoke or the smell of burning plastic occurs, turn off modules immediately and investigate the power supply and the wiring carefully.
- Make sure to record and keep product lot and installation date of the modules.

## STORAGE AND MAINTANANCE CONDITIONS

- Before the maintenance, turn off the power and maintain the modules after modules cool down. Otherwise, electric shock or burn may occur.
- Do not pull the wiring while removing the modules to prevent possible disconnections.
- Make sure to store modules at dry places, avoid elevated temperatures, high pressures, vibrations, corrosive or combustive gas, direct sunlight.
- Do not wipe or spray modules with volatile materials, such as thinner or benzene as it may lead to combustion and malfunctioning.
- Modules cannot operate at presence of materials containing sulphur components or where sulphur containing gas is generated as it leads to changes in light color and malfunctioning.

## GENERAL CONDITIONS

- Installation of modules must carried out by a qualified technician according to handling standards of electrical equipment.
- Modules and power supply have absolute maximum rating. Comply with the specifications to avoid failures or combustion.
- Avoid placing any high temperature objects around the modules, also avoid putting cloth or paper on the modules. It may lead to combustion, burnout, overheat, failure, deformation.
- Modules cannot be used in high-temperature environments, also they must not be subjected to vibration, shock, particles, corrosive or combustive gas. If not followed, it may cause fire, burnouts, bad insulation, failures, overheating and injuries.
- Do not insert or remove power plugs with wet hands to avoid electrical shock.
- While connecting or disconnecting electrical cords avoid being close to any heating equipment. It may lead to melting of the cords cause electrical shock.
- Do not modify the module. This may lead to electrical shock, failure, burnout, changes in module color.
- Do not install modules under direct sunlight or falling water. This may lead to electrical shock, burnouts, overheat, even combustion.
- While installing modules at humid areas, grounding of the power supply must be done.
- Modules cannot be used in combination with other types pf modules, as this may lead to failure.
- Modules can be used at ambient temperatures ranging from -30 °C to +50 °C..